

LCD display advanced digital temperature controller

User Manual

FT20X-800-C1

Please read this manual carefully and keep this manual for further reference

Features

- LCD three color VA display, bar graphic, output percentage MV1/MV2 or feedback MVFb display
- 0.2% measuring accuracy, maximum resolution 0.1 for TC and RTD input
- Output: relay, SSR drive, analog, triac, re-transmission
- Alarm: AL1/AL2 relay output, excitation, non-excitation, delay output, alarm lock function
Alarm mode: PV, deviation, absolute, band, alarm standby, PV deviation alarm ramp start-up alarm, ramp end alarm, Loop break alarm, heater break alarm
- Control mode: PID with auto-tuning, on/off, heating or cooling, heating+cooling, 3 wires proportional valve control, valve control with feedback signal, output restrain
- Program version: PID mode, ramp up mode, temp constant mode, soft-start
- Add-on feature: auto/manual control, run/stop function, even SV input
- Special features: all parameters distributed in three levels, parameters can be manually designate to different level
- Communication: RS-485, modbus-RTU, pattern 8-(N,0,E)-(1,2)
- Ambient temp 0-50°C, humidity 0-80%RH

1: Model number and ordering information

Please check this ordering information and specify the code when order with us

Model	FT200 (48mm*48mm)
Item number(Panel size: width x height)	FT204 (48mm*96mm)Vertical
	FT205 (96mm*48mm)Horizontal
	FT207 (72mm*72mm)
	FT209 (96mm*96mm)

1: Controller type

U	Standard PID type
T	Temperature constant mode(with timer)
R	Ramp and soak mode(with timer)
X	Motor valve direct/reverse control version(two relays)

2: OUTPUT 1

R	Relay output
V	SSR Drive/Voltage pulse output
D	4-20mA output
E	0-10Vdc
F	0-20mA
5	0-5Vdc
7	1-5Vdc
T	Triac single phase zero-crossing trigger
A	Relay output, for motor valve direct act control

3: OUTPUT 2(output 2 is only available for heating+cooling controller)

N	No output2(For single output controller, choose code N)
R	Relay output
V	SSR Drive/Voltage pulse output
D	4-20mA output
E	0-10Vdc
F	0-20mA
5	0-5Vdc
7	1-5Vdc
T	Triac single phase zero-crossing trigger
A	Relay output, for motor valve reverse act control

4: Number of Alarms

1	1 alarm
2	2 alarms
3	3 alarms

5: Power Source

96	85~265Vac 50/60HZ
24	24Vac/24Vdc

6: PV/SV re-transmission

N	No re-transmission function	F	4-20mA re-transmission via AU3
A	4-20mA re-transmission via OP2	G	0-20mA re-transmission via AU3
B	0-20mA re-transmission via OP2	K	0-10Vdc re-transmission via AU3
E	0-10Vdc re-transmission via OP2		

FT20X-800-C1

7:RS-485 Communication

N	No communication feature
K	RS-485 modbus RTU communication

8:AUX power source

N	No aux power	B	24Vdc grounded	D	12Vdc grounded
A	24Vdc isolated	C	12Vdc isolated		

9:Position feedback(analog feedback input from INP2)

N	No position feedback	A	4-20mA	B	0-20mA
C	0-5Vdc/potentiometer	D	1-5Vdc	E	0-10Vdc

10:Remote SV setting

N	No remote SV feature	A	4-20mA via INP2	B	0-20mA via INP2
C	0-5Vdc via INP2	D	1-5Vdc via INP2	E	0-10Vdc via INP2
F	4-20mA via INP3	G	0-20mA via INP3	H	0-5Vdc via INP2
J	1-5Vdc via INP3	K	0-10Vdc via INP3	W	D1/D2 terminals event input

11:Manual output% remote setting

N	No remote SV feature	A	4-20mA via INP2	B	0-20mA via INP2
C	0-5Vdc via INP2	E	0-10Vdc via INP2	F	4-20mA via INP3
G	0-20mA via INP3	H	0-5Vdc via INP3	K	0-10Vdc via INP3

2. Size and mounting

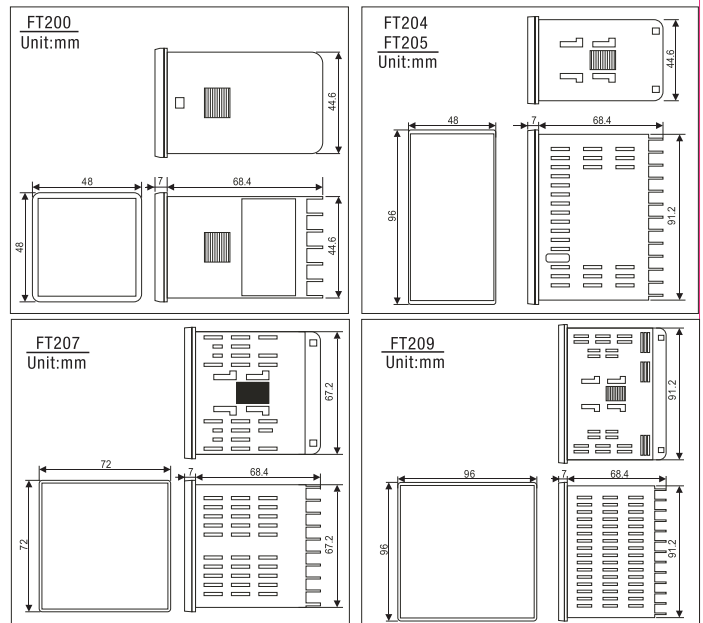

3. Wiring diagram

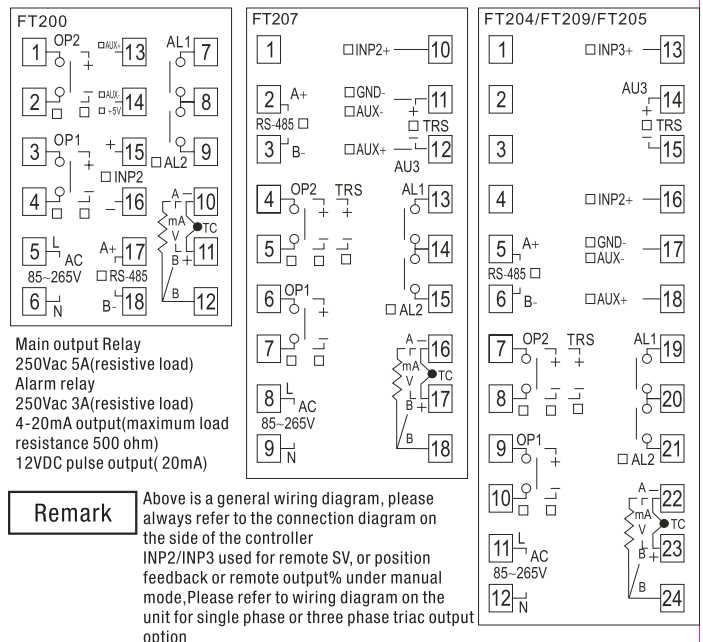

4. Panel description

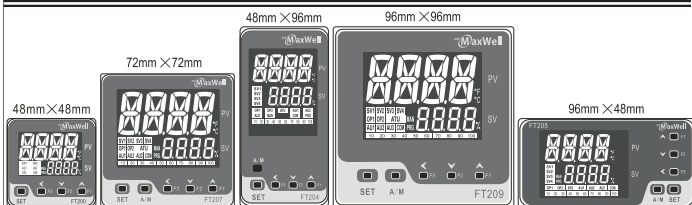

PV window: display PV and parameter notation
 SV window: display SV and parameter value
 Bar graphic: indicate output%, feedback value or re-transmission value

SET: Main function key
 A/M: Auto/manual switch key and enter key
 ◀ : Shift key (F3 function key, such as ATU fast initiated or go back to previous parameter)
 ▼ : Numeric decrease (F2 function key)
 ▲ : Numeric increase (F1 function key, Run/Stop)
 SV1: Event input SV1 indication
 SV2: Event input SV2 indication
 SV3: Event input SV3 indication
 SV4: Event input SV4 indication
 SV1 and SV2 light together indicate remote-SV

OP1: Indicate OP1 status
 OP2: Indicate OP2 status
 ATU: Indicate auto-tuning status
 AU1: AL1 alarm status
 AU2: AL2 alarm status
 AU3: Reserved light
 MAN: Manual control/soft-start indication
 COM: Communication indication
 PRG: Temp constant mode indication
 Ramp and soak indication

5. Setting and programming

5.1 Power on initialization

Power on stage shows the software version and edition, input type and setting value range

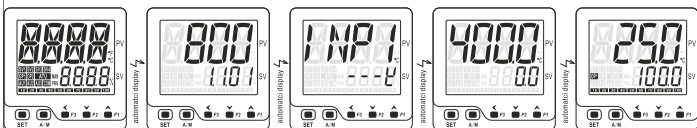

Notation	K	E	J	N	Wu3_Re25	S	t
Sensor type	K	E	J	N	Wu3_Re25	S	t
Range	-15 to 1300°C 0 to 2600°F	-15 to 800°C 0 to 1560°F	-15 to 1000°C 0 to 1950°F	-15 to 1300°C 0 to 2600°F	0 to 2200°C 0 to 3276°F	0 to 1600°C 0 to 3000°F	-15 to 400°C 0 to 782°F

Notation	r	b	AN1	AN2	F3	F4	Pt
Sensor type	r	b	DC0-50mV	DC10-50mV	Reserved	Reserved	Pt100
Range	0 to 1769°C 0 to 3216°F	0 to 1800°C 0 to 3276°F	-1999 to 9999	-1999 to 9999	Reserved	Reserved	-199 to 800°C -326 to 1472°F

5.1 SV configuration and parameter configuration

5.2.1 How to change the SV setting value, use the short cut key.

For example: change the SV from 0 to 200°C

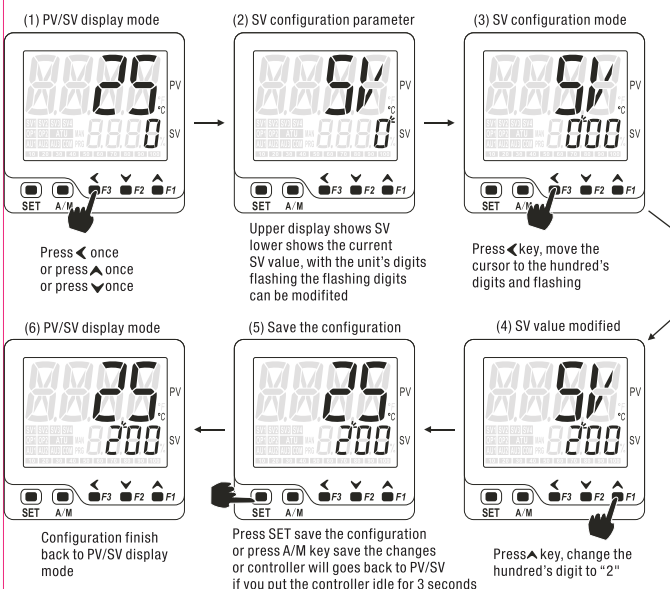

Remark 1: SV setting parameter can be assigned to different parameter menus, refer to S.F00 parameter for details

Remark 2: SV remote setting details, refer to "10. SV remote setting for more information"

5.2.2 How to configure all configurable parameters

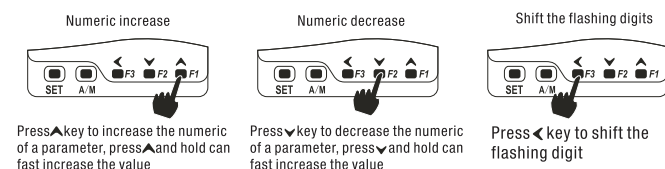

5.2.3 Shift between parameters and go back to previous parameter

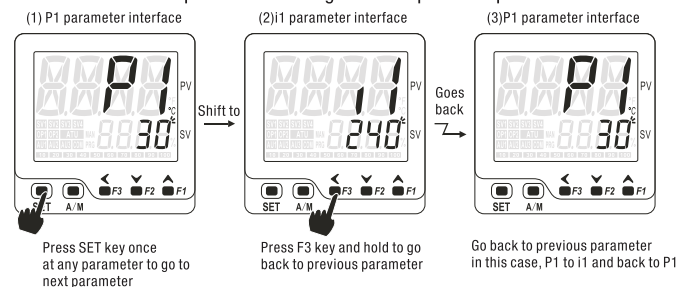

5.2.4 Save configuration and go back to normal PV/SV display mode

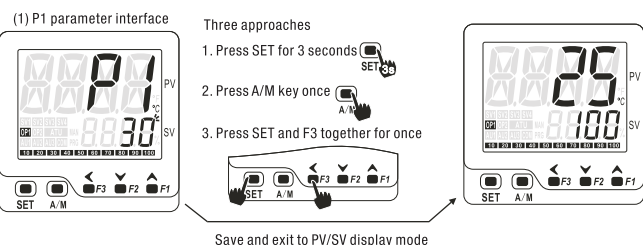

6. Parameter menu

6.1 Factory default parameter menu

6.1.1 Quick start menu level 1 (Press SET once to enter this menu)

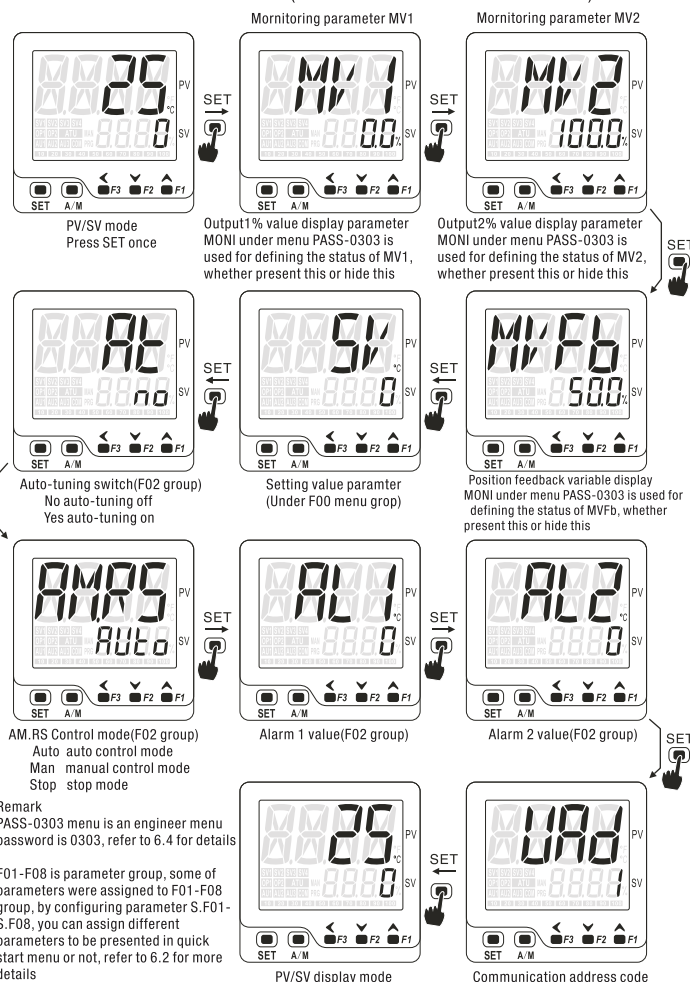

6.1.2 Quick start menu level 2 (Press SET for 3 seconds to enter)

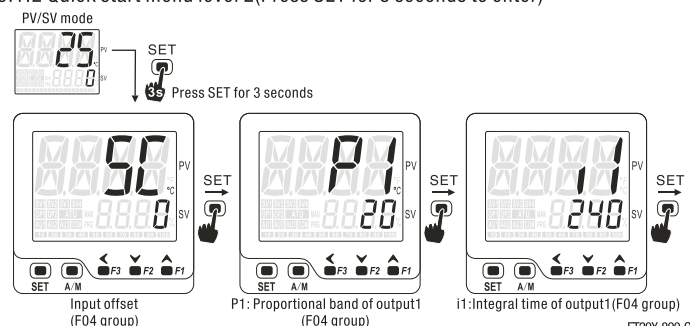

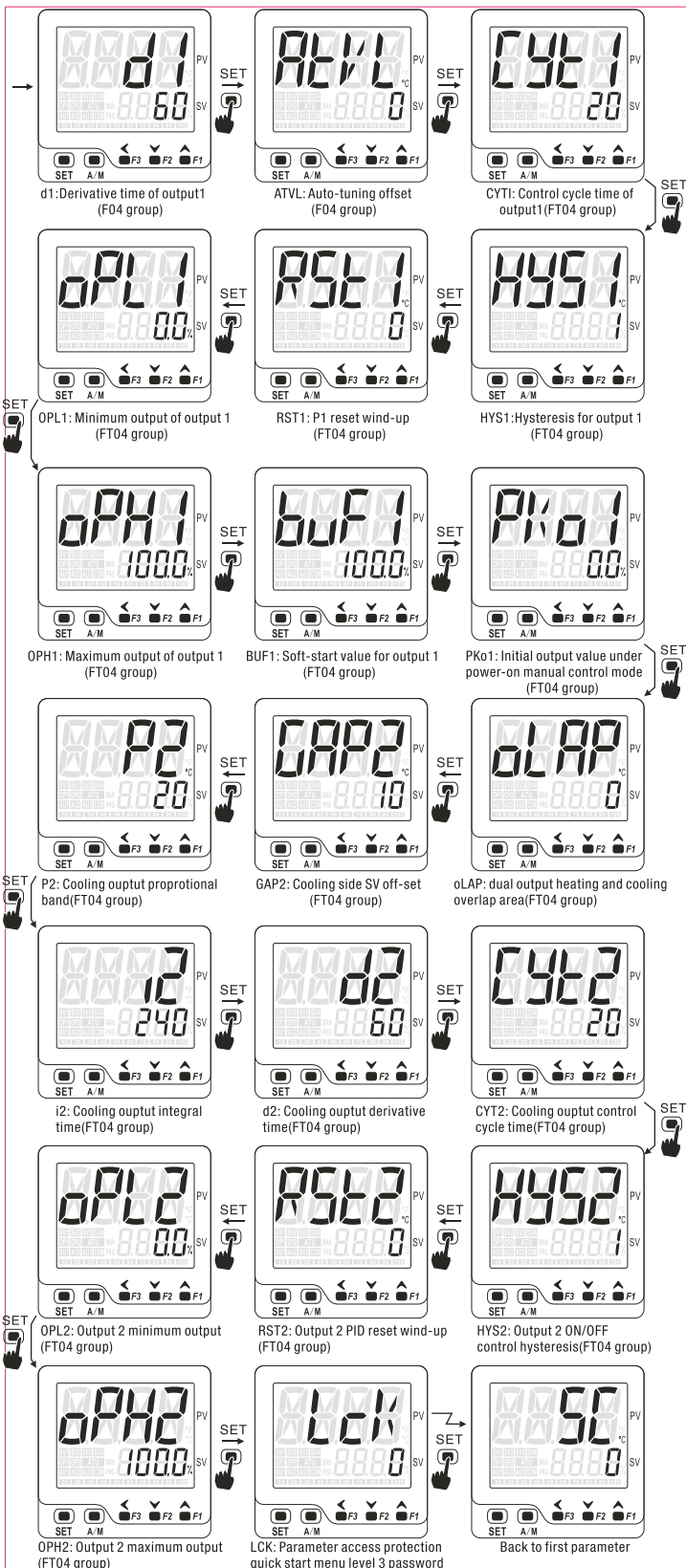

Remark: All the parameters are distributed under ground F01, F02, F03, F04, F05, F06, F07, F08 some goes to group F01 and others goes to F02 etc. S.F01-S.F08 parameter is used to define whether present or hide specific parameters under different menu group

6.1.2 Quick start menu level 3 (custom menu, access with password)

This is a customized menu, you can put those frequently used parameters which likely being incorrectly manipulated under this menu, password is required if you want to access to this menu this will prevent unauthorized access and configuration

Lck: password to access menu level 3 Customized parameters, there is no parameters under this menu as factory default

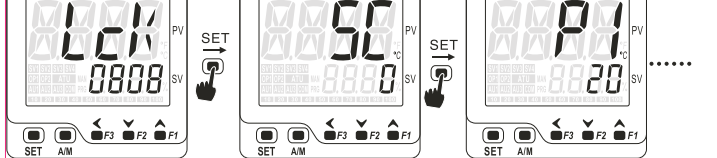

Lck: quick start menu (F08) S.F08 parameter defines the presence of this menu when Lck=0808, press SET key

Remark: F01-F06 parameters were distributed to these groups S.F01-S.F06 used to define the presence of these parameter groups refer to "6.2 basic functional menu (F menu)" for more details

6.2 Basic functional parameter menu (F menu)

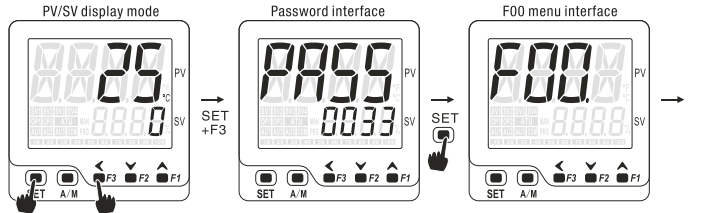

Press SET and F3 key once, goes to password interface Set PASS=0033 enter into F menu F00 menu, press F1 or F2 key to shift between F00-F08

F00 menu group

Notation	Name	Description	Default
SV	setting value	Setting value Range defined by (LSPL to USPL)	0
SF00	define the status of F00 group parameters	0: Do not present F00 under quick start menu Press F1, F2, F3 to SV setting mode 1: Present F00 at quick start menu level 1 2: Present F00 at quick start menu level 2 3: Present F00 at quick start menu level 3	0

F01 menu group, for controller with event SV setting features only

Notation	Name	Description	Default
SV1	Event input SV1	SV setting configured by external D1/D2 terminals SV1 D1: open D2: open, SV=SV1	1
SV2	Event input SV2	SV setting configured by external D1/D2 terminals SV2 D1: open D2: close, SV=SV2	2
SV3	Event input SV3	SV setting configured by external D1/D2 terminals SV3 D1: close D2: open, SV=SV3	3
SV4	Event input SV4	SV setting configured by external D1/D2 terminals SV4 D1: close D2: close, SV=SV4	4
SF01	define the status of F01 group parameters	0: Do not present in quick start menu 1: Present F00 at quick start menu level 1 2: Present F00 at quick start menu level 2 3: Present F00 at quick start menu level 3	0

F02 menu group

Notation	Name	Description	Default
AT	Auto-tuning	No.: Auto-tuning off Yes.: Auto-tuning on	no
AM, RS	Operating mode	Auto.: auto control mode MAN.: manual control mode StoP.: stop mode	Auto
AL1	Alarm 1 value	Alarm value for alarm 1, range -1999~9999	10
AL2	Alarm 2 value	Alarm value for alarm 2, range -1999~9999	10
UAD	Device address	Define device address in RS-485 system	1
SF02	define the status of F02 group parameters	0: Do not present in quick start menu 1: Present F00 at quick start menu level 1 2: Present F00 at quick start menu level 2 3: Present F00 at quick start menu level 3	1

F03 menu group, some of parameters under F03 might not be displayed due to different controller version

Notation	Name	Description	Default
RAMP	Ramp	Ramp rate under ramp up heating mode Unit is °C/minute	1
t1	timer range	t1 is a time duration for temperature constant mode or ramp up mode minutes or seconds, t1=0, temperature constant mode disabled parameter t1UN under PASS-0303 define the t1 unit	0
SF03	define the status of F03 group parameters	0: Do not present in quick start menu 1: Present F00 at quick start menu level 1 2: Present F00 at quick start menu level 2 3: Present F00 at quick start menu level 3	0

F04 menu group

Notation	Name	Description	Default
SC	Input offset	Input offset, to compensate the error caused by sensor Range, for temp.: -199~199, for analog., -1999 to 1999	0
P1	Proportional band of output 1	Proportional band of output 1, range 0-800	20
i1	integral time	Integral time of output 1, range 0-3600 seconds when i1=0, integral off	210
d1	Derivative time	Derivative time of output 1, range 0-3600 seconds When d1=0, derivative off	30
ALVL	Auto-tuning SV offset	Shift the SV value lower to prevent large overshoot during auto-tuning process range -199-199	0
CYT1	Cycle time for output 1	cycle time for output 1, CYT1=20 seconds for relay CYT1=2 seconds, CYT1 not applicable for analog output	20
HYS1	Hysteresis for output 1	When P1=0, ON/OFF control, HYS1 0.1-900 Heating: OP1 stop PV<SV OP1 active when PV<SV-HYS1 Cooling: OP1 active when PV>SV+HYS1 OP1 stop PV<SV	0
RST1	Time proportional reset	When i1=0, d1=0, pure proportional control, rSt1 is reset value Heating, out 1%=(SV+rSt1-PV)/P1*100% Cooling, out 1%=(PV-SV-rSt1)/P1*100% this used to suppress overshoot at start-up for PID control Heating, suppress more when rst 1 gets smaller Cooling, suppress more when rst 1 gets bigger range: -199~199	0
OPL1	minimum output for out1	Minimum output value 0.0 to 100.0%	0.0
OPH1	maximum output for out1	Maximum output value 0.0 to 100.0%	100.0
BUF1	Output 1 restrain	Output restrain for analog output, output restriction, only applicable for analog output controller for example, if buf=5%, means the output changing ratio will be less than 5% per second	100.0
PKO1	Initial output %	Define the output ratio when temperature configured as manual output after power on	100.0
oLAP	heating/cooling overlap	Heating/cooling control overlap, range 0-100, overlap area is (SV-oLAP)-(SV+oLAP)	2

To the next page

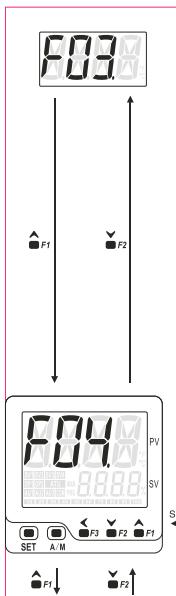

Notation	Name	Description	Default
GAP2	Cooling control SV offset	Define the cooling control SV value cooling control SV=SV+GAP2. Range: 0~200. For example, SV=100, GAP2=10. Then cool side SV=100+10	0
P2	P2 for cooling control	Proportional band for output 2, unit is degree range 0~800, P2=0 for ON/OFF control mode	20
I2	Integral time I2 for output 2	Integral time for output 2 range 0~3600 seconds I2=0 integral action off	210
D2	Derivative time for output 2	Derivative time for output 2 range 0~3600 seconds D2=0 derivative action off	30
CYCL2	Control period for output 2	Control period for output 2, 20 seconds for relay output, 2 seconds for SSR drive output	20
HYS2	Hysteresis for output 2	When P2=0, on/off control for output 2. HYS2 range 0.1~900, OP2 active when PV>SV+HYS2 OP2 stop when PV<SV-GAP2	0
RST2	time proportional reset, rSt2	When I2=0, D2=0, proportional control out2%=(PV-SV-GAP2-rst2)/P2*100% suppress the overshoot after power on range: -199~199	0
OP2	Minimum output for output 2	Minimum output for output 2 range 0.0~100%	0.0
OPH2	Maximum output for output 2	Maximum output for output 2 range 0.0~100%	100.0
SF04	Define status of F04 group parameters	0: Absent 1: Present in quick start menu 1 2: Present in quick start menu 2 3: Present in quick start menu 3	2

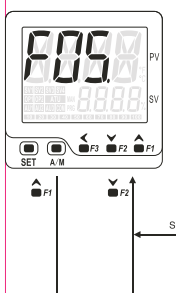

Notation	Name	Description	Default
SFSV	Soft-start SV	SFSV range: -199~3275 SIME range: 0~100 minutes Sout range: 0.0~100.0%	0
SIME	Soft-start period	Soft-start function 1. Power on, heating control, if PV<SFSV, soft start active 2. Power on, cooling control, if PV>SFSV, soft start active 3. MAN indicator flashes, out% = "Sout" value 4. PID heating, when PV>SFSV or SIME time reached, soft-start off 5. PID cooling, when PV<SFSV or SIME time reached, soft-start off 6. MAN indicators off when soft-start terminated 7. SIME=0, soft-start function disabled	0.0
Sout	Soft-start out%		0.0
SF05	Define status of F05 group parameters	0: Absent 1: Present in quick start menu 1 2: Present in quick start menu 2 3: Present in quick start menu 3	0

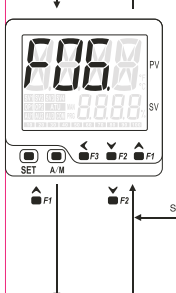

Notation	Name	Description	Default
LBAE	LBA check time	Under heating mode(100% output), if the temperature did not increase LbAb within LbAt period, LBA will be triggered	80
LBAF	LBA temperature differential	Under cooling mode(100% output), if the temperature did not drop LbAb within LbAt period, LBA will be triggered	2
HBAE	Heater short circuit time	Under heating mode, if temperature increase HbAb within HbAt period at output 0% HBA goes off	180
HBAF	Temperature differential	Under cooling mode, if temperature drops HbAb within HbAt period at output 0% HBA goes off	10
SF06	Define status of F06 group parameters	0: Absent 1: Present in quick start menu 1 2: Present in quick start menu 2 3: Present in quick start menu 3	0

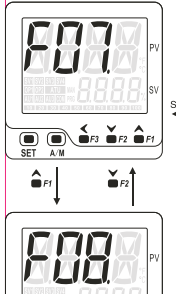

Notation	Name	Description	Default
1LR	ALM1 interlock	if alarm 1 interlocked, 1LR=1 put 1LR=0 can disengage the interlock	0
2LR	ALM2 interlock	if alarm 2 interlocked, 2LR=2 put 2LR=0 can disengage the interlock	0
SF07	Define status of F07 group parameters	0: no shortcut for interlock disengage 1: shortcut for interlock disengage available Press F1 and F2 at the same to quick access to 1LR and 2LR	0

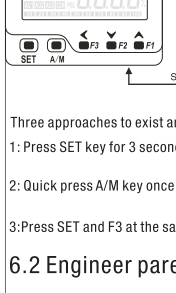

Notation	Name	Description	Default
LCK	Access protection and password for quick start menu 3	=0/1: all parameters can be modified =2: F06 group of parameters locked =3: F05, F06 parameters locked =4: F04, F05, F06 parameters locked =5: F03, F04, F05, F06 parameters locked =6: F02, F03, F04, F05, F06 parameters locked =7: F01, F02, F03, F04, F05, F06 parameters locked =8: F00, F01, F02, F03, F04, F05, F06 parameters locked =0808: Press SET to quick start menu 3	0
SF08	Define status of F08 group parameters	0: Absent 1: Present in quick start menu 1 2: Present in quick start menu 2 3: Present in quick start menu 3	2

Three approaches to exist and save the configuration under F menu

- 1: Press SET key for 3 seconds
- 2: Quick press A/M key once
- 3: Press SET and F3 at the same time

6.2 Engineer parameter (PASS-0101 menu)

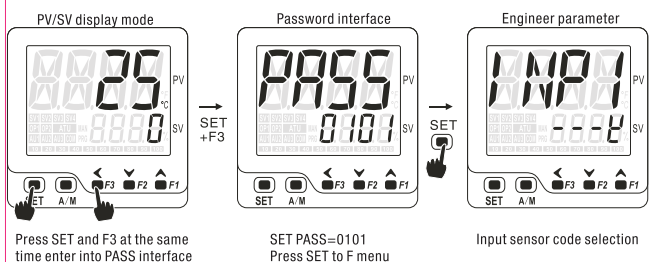

Press SET and F3 at the same time enter into PASS interface

SET PASS=0101
Press SET to F menu

Input sensor code selection

Depends on the specific functions
some of parameter may or may not be available

Notation	Name	Description	Default	Remark				
INP1	Input sensor code selection INP1							
	Symbol	\bar{L}	\bar{E}	\bar{J}	\bar{N}	\bar{U}	\bar{S}	\bar{L}
	input	K	E	J	N	Wd3, Re25	S	L
	range	-15 to 1300°C 0 to 2600 °F	-15 to 800°C 0 to 1560 °F	-15 to 1000°C 0 to 1950 °F	-15 to 1300°C 0 to 2600 °F	0 to 2200°C 0 to 3275 °F	0 to 3000 °F	-15 to 400°C 0 to 782 °F
	Symbol	\bar{r}	\bar{b}	AN1	AN2	F3	F4	PL
	input	r	b	DC0-50mV	DC10-50mV	Reserved	Reserved	PI100
	range	0 to 1789°C 0 to 3216 °F	0 to 1800°C 0 to 3276 °F	-1999 to 9999	-1999 to 9999	Reserved	Reserved	-199 to 800°C -326 to 1472 °F
DP	Decimal point dP	0, 1, 2, 3	0	TC/RTD input, 0: without decimal point, 1: 1 decimal point Analog input: 0: without decimal point, 1: 1 decimal point, 2: 2 decimal points 3: 3 decimal points				
UNIT	Display unit UNIT	°C, °F, no	°C	°C: Celsius °F: Fahrenheit No: No unit				
LSPL	SV lower limit LSPL	Temp: -199~3276 Analog: -1999~9999	0	SV lower limit Remote-SV lower limit input display value				
USPL	SV higher limit USPL	Temp: -199~3276 Analog: -1999~9999	400	SV higher limit Remote-SV higher limit input display value				
PVOS	input offset PVOS	Temp: -199~199 Analog: -1999~9999	0	To compensate the input error caused by the sensor				
PVFE	Input filter strength PVFE	0 to 60	5	1-30 normal input filter strength 31-60 enhanced input filter strength				
ANL1	lower limit display for analog input	-1999~9999	0	Display for analog input at its lower limit value "ANL1"				
ANH1	higher limit display for analog input	-1999~9999	2000	Display for analog input at its higher limit value "ANH1"				
LRSL	Transmission output lower limit LRSL	-1999~9999	0	Display for re-transmission at its lower limit value				
LRSH	Transmission output higher limit LRSH	-1999~9999	400	Display for re-transmission at its higher limit value				
ALD1	Alarm mode for alarm 1	00 to 16	11	To configure the alarm mode of alarm 1				
AH1	Alarm hysteresis for alarm 1	0 to 9999	0	Hysteresis value for alarm 1				
ALD1	Alarm 1 delay time	0 to 9999 seconds	0	Alarm delay time for alarm 1 only applicable for ALD1=01~06 and 11~16, Alarm 1 will be triggered after delay time ALD1				
ALD2	Alarm mode for alarm 2	00 to 16	10	To configure the alarm mode of alarm 2				
AH2	Alarm hysteresis for alarm 2	0 to 9999	0	Hysteresis value for alarm 2				
ALD2	Alarm 2 delay time	0 to 9999 seconds	0	Alarm delay time for alarm 2 only applicable for ALD2=01~06 and 11~16, Alarm 2 will be triggered after delay time ALD2				
OP1	OP1 output mode	0 or 1	0	0: reverse control(heating) 1: direct control(cooling)				
BER1	OP1 analog output restriction	0, 1, 2	0	0: output restriction off 1: output restriction on 2: output restriction on when output increase, restriction off when output decrease				
PUCY	motor valve travel time	0-200 秒	60	This parameter assign the travel time for the motor valve means the time for the valve from full open to full close this is only application for motor valve without position feedback				
SSRM	Triac triggering mode	Stnd CYCL PHAS	PHAS	Stnd: SSR Drive output, zero-crossing trigger CYCL: Random trigger PHAS: Phase angled trigger				
PMD	Program execution mode	0, 1, 2	0	Only applicable for temp constant and ramp and soak mode 0: Standard mode 1: temp constant mode 2: ramp and soak mode				
TSP	TSP	0 to 9999	1	This parameter defines the temperature when the timer kicks in Temperature(TSP) for timer kicks in= SV-TSP when PV=SV-TSP and stay for 5 seconds then timer kicks in =0, PID control off when timer finish =1, PID control goes on when timer finish power interruption or press F1 for 3 seconds will re-start				
PEND	PENd	0, 1	1					
IdNO	IdNO	0-255	1	Device address configuration				
bAud	bAud	2.4 4.8 9.6 19.2	9.6	2.4 Baud rate 2400 bps 4.8 Baud rate 4800 bps 9.6 Baud rate 9600 bps 19.2 Baud rate 19200 bps				
UCR	UCR	N,O,E	N	N: 8 data bit, + No parity+1 stop bit(8N1) O: 8 data bit, + odd parity+1 stop bit(8O1) E: 8 data bit, + Even parity+1 stop bit(8E1)				

Alarm mode(ALD=00~16)

- 10: No alarm
- 11: Deviation high alarm
- 12: Deviation low alarm
- 13: Deviation high/low alarm
- 14: Deviation band alarm
- 15: Process high alarm
- 16: Process low alarm
- 00: No alarm
- 01: Deviation high alarm with standby function
- 02: Deviation low alarm with standby function
- 03: Deviation high/low alarm with standby function
- 04: Deviation band alarm with standby function
- 05: Process high alarm with standby function
- 06: Process low alarm with standby function
- 09: LBA alarm
- 19: HBA heater short circuit alarm
- 17: Timer kick-in alarm
- 18: Timer finish alarm
- 21: Setting value high alarm
- 22: Setting value low alarm
- 23: Process value limit value

6.2.1 Alarm mode details

Code	ALD	Specification(Example for alarm 1)
N	10 or 00	No alarm
A	11	Deviation high alarm AL1>0 LOW SV HIGH SV+AL1 AH1 Alarm ON
	11	Deviation high alarm AL1<0 LOW SV+AL1 HIGH SV AH1 Alarm ON
B	12	Deviation low alarm AL1>0 LOW SV+AL1 HIGH SV AH1 Alarm ON
	12	Deviation low alarm AL1<0 LOW SV+AL1 HIGH SV AH1 Alarm ON
C	13	Deviation high/low alarm LOW SV-AL1 SV SV+AL1 HIGH AH1 Alarm ON

D	14	Deviation band alarm	
H	15	Process high alarm	
J	16	Process low alarm	
E	01	Deviation high alarm with hold action	
		Deviation high alarm with hold action	
F	02	Deviation low alarm with hold action	
		Deviation low alarm with hold action	
G	03	Deviation high/low alarm with hold action	
M	04	Deviation band alarm with hold action	
K	05	Process high alarm with hold action	
L	06	Process low alarm with hold action	
V	21	SV high alarm	When SV >= AL1, AL1 on, When SV < AL1 - AH1, AL1 off
W	22	SV low alarm	When SV <= AL1, AL1 on, When SV > AL1 + AH1, AL1 off
P	23	Process value limit alarm	
R	09	LBA loop break alarm	
Q	19	Heater short circuit alarm	
3	17	timer kick-in alarm	
4	18	timer finish alarm	

Note: The alarm action will be suppressed right after power on even the condition is satisfied, and the alarm standby on works 1 time right after power on, the alarm will go off if the condition satisfied again after suppression at the first time

6.3 Engineer parameter (PASS-0202 menu)

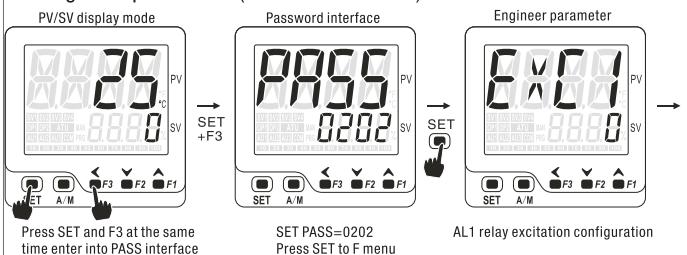

Engineer parameters menu "0202"(PASS-0202)

Notation	Name	Range	Default	Remark
	AL1 relay excitation	0, 1	0	0: AL1 relay pull-in when alarm 1 triggered 1: AL1 relay release when alarm 1 triggered
	AL1 interlock	0, 1	0	0: AL1 output standard mode 1: AL1 output interlock mode
	AL2 relay excitation	0, 1	0	0: AL2 relay pull-in when alarm 2 triggered 1: AL2 relay release when alarm 2 triggered
	AL2 interlock	0, 1	0	0: AL2 output standard mode 1: AL2 output interlock mode

6.3.1 Alarm interlock disengaged procedure

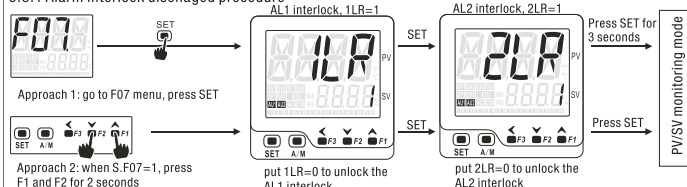

6.4 Engineer parameter menu 3 (PASS-0303 menu)

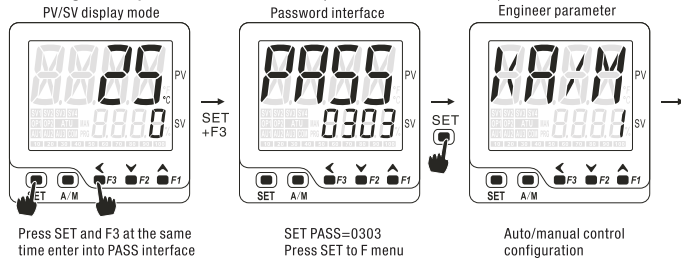

Depends on the specific functions some of parameter may or may not be available

Notation	Name	Range	Factory default	Remark
	Auto/manual control switch configuration	0, 1	1	0: A/M key disabled 1: A/M Key enable (press A/M key 3 seconds to switch)
	Run/Stop function configuration	0, 1	0	0: Disable RUN function active by F1 key 1: Enable RUN function active by F1 key 0: Disable STOP function active by F2 key 1: Enable STOP function active by F2 key
	Auto-tuning short cut key	0, 1	0	0: Disable auto-tuning active by F3 key 1: Enable auto-tuning active by F3 key
	Power on control mode	0, 1, 2, 3	0	0: Auto control mode after power on 1: Stop mode after power on 2: Manual control mode after power on Initial output value defined by PK01 parameter 3: Controller continue the status from where it left off
	soft-start function configuration	0, 1	0	0: Disable soft-start function 1: Enable soft-start function
	Re-transmission configuration	0, 1	0	0: PV re-transmission 1: SV re-transmission
	Position feedback configuration	0, 1	0	0: Position feedback disabled 1: Position feedback enable for close loop control
	Remote SV	0, 1	0	0: Remote SV off 1: Remote SV on (panel SV setting off) 2: Remote SV on (panel SV setting on)
	Quick start menu 1 configuration	0, 1, 2, 3	1	0: MV1, MV2, MVFb absent in quick menu 1 1: MV1, MV2, present in quick menu 1, MVFb absent 2: MVFb present in quick menu 1, MV1, MV2 absent 3: MV1, MV2, MVFb present in quick menu 1
	Bar graphic display configuration	0, 1, 2, 3	0	0: Bargraphic for OP1 % 1: Bargraphic for OP2 % 2: Bargraphic for TRS % 3: Bargraphic for MVFb %
	Timer unit	0, 1	0	0: Timer unit " second" 1: Timer unit " minute"
	manual output % remote setting	0, 1	0	0: Manual output % set via key pad 1: Manual output % set via remote signal

Three approaches to exist and save the configuration under F menu

- 1: Press SET key for 3 seconds
- 2: Quick press A/M key once
- 3: Press SET and F3 at the same time

7. Auto-Tuning

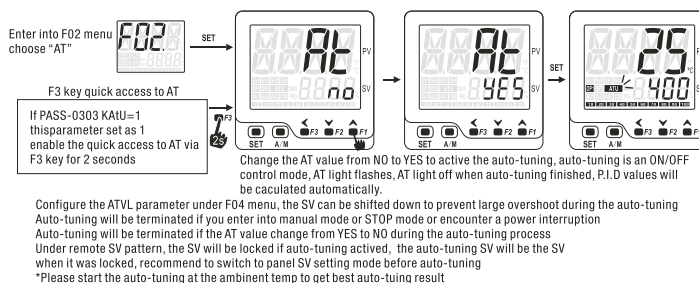

8. Auto manual control switch

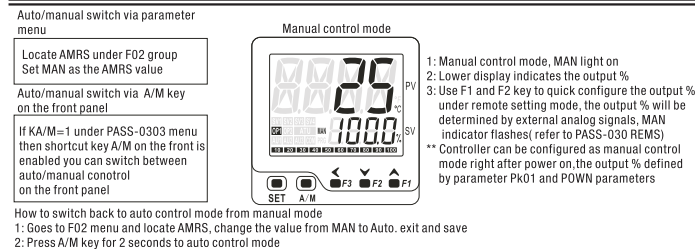

9. RUN/STOP function

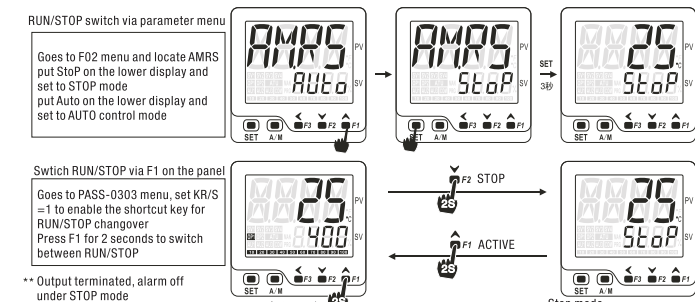

10. SV Panel setting and remote setting

10.1 Remote setting SV, use D1/D2 terminals at the back to set the SV

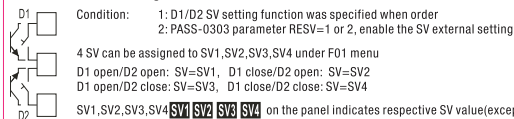

10.2 Remote setting SV via external analog signal input from INP2 or INP3

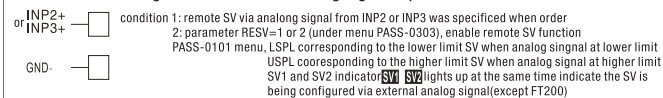

10.3 Switch between SV remote setting and SV panel setting

Goes to PASS-0303 and set RESV=2, quick switch between remote SV setting and panel SV setting enabled, enter into remote SV mode after power on

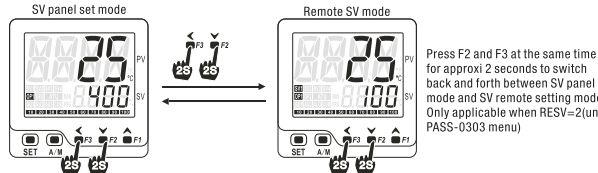

11. Three wires motor valve control

This is only available for valve control version of controller please specify if you need position feedback or not when order with us, output: OP1 for valve direct acting (open), OP2 for valve reverse acting (close), make sure to put the motor valve on the intermediate relay or AC contractors. You can also go to PASS-0303 and set PFBk=0 and switch off the position feedback function in case you've already ordered a controller with position feedback feature, the motor valve travel time must be specified via RUCY parameter under PASS-0101 menu in a no position feedback case. Quick start menu parameter MVFb is a monitoring parameter for the valve feedback value, this can be configured via parameter MoNI under PASS-0303, the bargraphic can also be used to indicate the feedback value, this can be configured via bEAM under PASS-0303

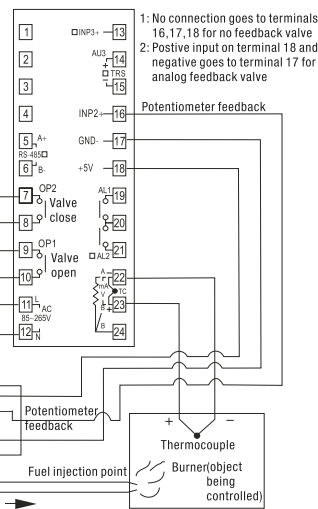

12. Position feedback calibration and operation

Condition
1: Position analog feedback via terminal INP2 ordered (only applicable for 3 wires motor valve or analog output controller)
2: PFBk=1, position feedback enabled for close loop control
General feedback signal, 1) standard analog signal, 2) Potentiometer feedback signal, specify when order

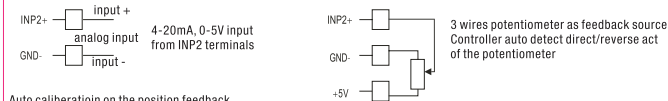

Auto calibration on the position feedback

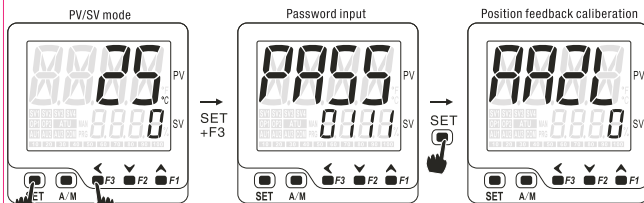

PV/SV mode, press SET and F3 at the same time PASS pop-up

Position feedback "0" point calibration

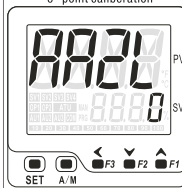

1. 3 wires motor valve auto calibration
Upper shows AA2L, OP1 light on, OP2 relay pull-in, motor reverse act, lower display changes along with the motor reverse act, display switch to one at right after some while, "0" point calibration finished

Position feedback "maximum" point calibration

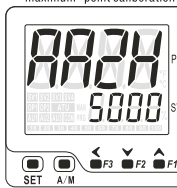

2. for analog output, upper shows AA2H, OP1 output 100%, lower display changes along with the valve feedback signal, display changes to the right after some while, process finished

PV/SV mode

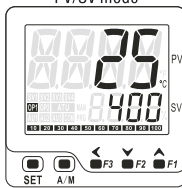

Calibration finish, goes back to PV/SV mode, these process always carried out automatically, user shall only observe the lower display changes, MVFb can be used to monitor the feedback value, MoNI under PASS-0303 used to define the status of MVFb
Bargraphic % display can be used to shows the feedback %, bEAM under PASS-0303 used to define the status of the bargraphic display

13. Temp constant mode and ramp/soak mode

This is only applicable for programmable version of controller, specify when order

13.1 Parameters that involved

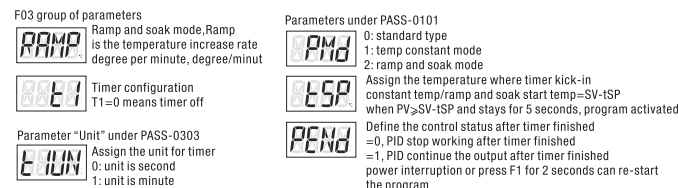

13.2 Ramp and soak mode detailed working flow chart PMd=2

1. program execute: power-on, lower display shows SV, this will delay 5 seconds before the program starts, PRG lights on during the ramp and soak process, lower display starts to indicate the PV value, PV increase gradually based on the preset ramp up rate towards to SV value
2. Timer kick-in: when PV > SV-ISP for at 5 seconds, timer kick-in, lower display shows the timer, PRG flashes, timer range is t1 value, timer starts alarm and timer finish alarm can be configured, refer to PASS-0101 ALD1 and ALD2
3. Timer finish: when timer finish, PRG light on, based on PEND parameter under PASS-0101, output can be configured as continue working or stop, when alarm mode=18, alarm will be triggered after timer finish
4. program terminated: if PEND=0 configured, program ends after timer finish, lower display shows "End" main output off, press F1 for 2 seconds can enter into STOP mode or active the program again

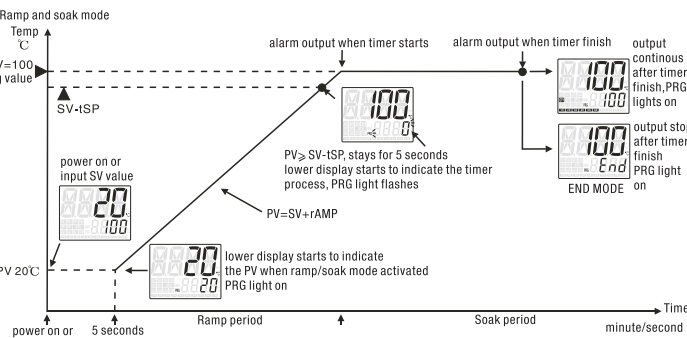

13.3 Temp constant mode working flow chart PMd=1

1. Program activate: lower shows SV, and heatup towards SV immediately
2. Timer kick-in: when PV > SV-ISP stays for 5 seconds, timer activated, lower display shows timing process, PRG flashes, timer range is t1 value, an alarm can go off when timers starts by configuring the ALD1 or ALD2=17 under PASS-0101
3. Timer finish: when timer finish, PRG light on, based on PEND parameter under PASS-0101, output can be configured as continue working or stop, when alarm mode=18, alarm will be triggered after timer finish
4. program terminated: if PEND=0 configured, program ends after timer finish, lower display shows "End" main output off, press F1 for 2 seconds can enter into STOP mode or active the program again

14. RS-485 communication brief

- (1) Communication based on modbus RTU, support 03 read command, 06 and 10 write command
- (2) Communication format, 2 wires system, half-duplex, single drop connection
- (3) Communication speed: 2400, 4800, 9600, 19200 baud rate, data format, 1 start bit+ 8 data bit+parity(N.o.E)+1/2 stop bit
- (4) Support maximum 36 write command and 37 read command
- (5) Detailed setting goes to PASS-0101 and locate parameter ldn0, bAud, UCR parameters
- (6) Refer to "COM-800-C1" for detailed communication protocol information

15. Input sensors and range

Input type	Code	Input type	Code
0.0 to 200.0 °C	K D2	0.0 to 100.0 °C	D D1
0.0 to 400.0 °C	K D4	0.0 to 200.0 °C	D D2
0 to 400 °C	K A4	-50.0 to 200.0 °C	D G2
0 to 600 °C	K A6	-100.0 to +200.0 °C	D F2
0 to 1300 °C	K B3	-199.9 to +200.0 °C	D F3
0.0 to 200.0 °C	E D2	0 to 100 °C	D A1
0.0 to 300.0 °C	E D3	0 to 200 °C	D A2
0 to 200 °C	E A2	0 to 400 °C	D A4
0 to 400 °C	E A4	0 to 800 °C	D A8
0 to 800 °C	E A8	-100 to 200 °C	D C2
0.0 to 300.0 °C	J D3	-200 to 400 °C	D C4
0.0 to 400.0 °C	J D4	-200 to 600 °C	D C6
0 to 300 °C	J A3	-200 to 800 °C	D C8
0 to 400 °C	J A4		
0 to 1000 °C	J A0		
0 to 300 °C	T D4		
0 to 400 °C	T A4		
0 to 1600 °C	S B6		
0 to 1769 °C	R B8		
200 to 1800 °C	B B8		
0 to 1300 °C	N B3		
600 to 2200 °C	W B0		

Input type	Code
AN1 0 to 50mV	V 02
AN2 10 to 50mV	V 10
AN3 0 to 5VDC	V 03
AN3 0 to 10VDC	V 04
AN4 1 to 5VDC	V 08
AN4 2 to 10VDC	V 09
AN4 4 to 20mA	A 03
AN3 0 to 20mA	A 02
AN3 0 to 10mA	A 01

The accuracy is not guaranteed for type S thermocouple in the range of 0-100

Remark 1: user can switch input between thermocouple and RTDs via software

Remark 2: analog input except 0-50mA, 10-50mV needs to be specified when order